

NOVARA FLOOR VANITY 900 2X DRAWER - SQUARE POLYMARBLE

ELEMENTI

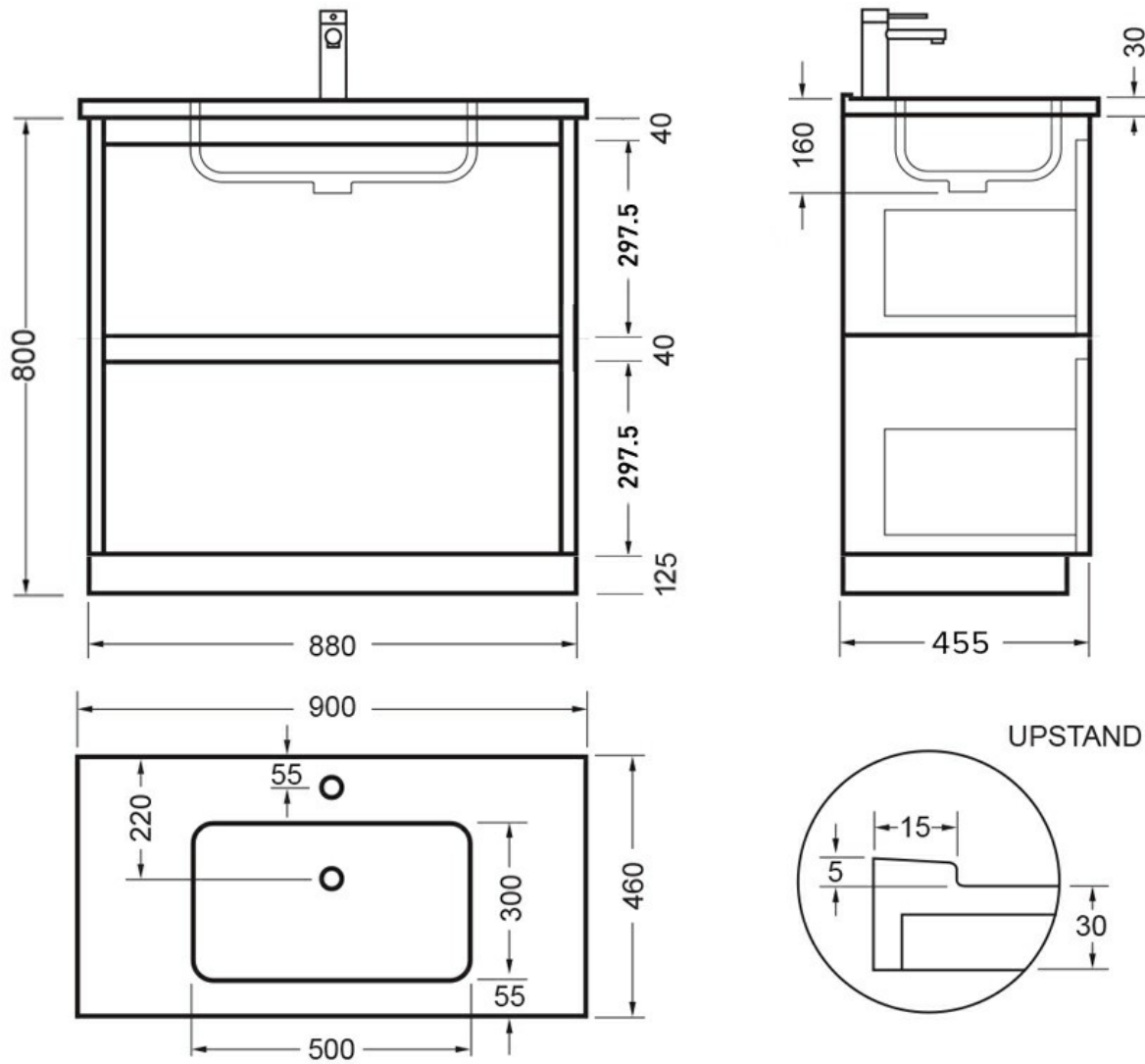

Silica Free

No use of Silica on vanity tops making it safer for you & the family



Residential/Light Commercial Use

Suitable for Residential/Light Commercial Use (Kitchens, Bathrooms and Laundries in Hotels, Motels and Retirement Villages).



Guarantee

5 Year Guarantee



Hafele Lifetime Warranty

All Hafele Hardware comes with a Lifetime Warranty.



Moisture Resistant

Made from Moisture Resistant Board



Soft Close Drawer System

Incorporates Soft Close Drawer and Doors.

---



Environmental Choice

Product manufactured predominantly from sustainably grown New Zealand plantation pine forests and is Environmental Choice Certified.

---



Made in New Zealand

Designed & Engineered in New Zealand

---

Crisp lines, a clean finish and impressive features are what defines the Novara vanity range. To provide more drawer space, a second drawer has been added.